

MARS (MH) VERTICAL STACK
CHASSIS REPLACEMENT SERIES

INSTALLATION, OPERATION & MAINTENANCE MANUAL

Part#: 97B0183N01 | Created: December 20, 2024

Models: MH 09-36
60Hz – R-454B



Models:
MH
09-36

Table of Contents

3	Model Nomenclature	17	Hose Kit and Chassis Installation MHM/ MHS/MHC/MHD (TSM/TSL replacement)
4	Attentions, Cautions, and Warnings	20	Electrical Data
6	General Information	21	Wiring Diagrams
8	Refrigerant System Servicing	28	Preventative Maintenance
11	Existing Chassis R-454B MH Replacement Models	29	Startup Log Sheet
12	Conversions and Compatibility	30	Functional Troubleshooting
13	Existing Chassis to Replacement MH Series Water Connection Dimensions Chart	33	Performance Troubleshooting
14	Chassis Pre-installation and Chassis Installation MH8 (816-817 replacement)	35	Troubleshooting Form
16	Chassis Pre-Installation MHM/MHS/ MHC/MHD (TSM/TSL replacement)	36	Revision History

MARS works continually to improve its products. As a result, the design and specifications of each product at the time of order may be changed without notice and may not be as described herein. Please contact MARS's Customer Service Department at 517-787-2100 for specific information on the current design and specifications. Statements and other information contained herein are not express warranties and do not form the basis of any bargain between the parties, but are merely MARS' opinion or commendation of its products.

Model Nomenclature

1 | 2 | 3 | 4 | 5 | 6 | 7 | 8 | 9 | 10 | 11 | 12 | 13 | 14 | 15
M | **H** | **C** | **0** | **9** | **G** | **G** | **S** | **0** | **S** | **S** | **C** | **A** | **A** | **A**

SERIES
 MH = R-454B Replacement High-Rise Chassis

REPLACEMENT CHASSIS MODEL
 8 = 816-817 Chassis
 R = TRM Chassis
 M = TSM Rev A-B Chassis (Sizes 09-12 Only)
 S = TSL Rev A-B Chassis (Sizes 09-12 Only)
 C = TSM Rev C Chassis
 D = TSL Rev C Chassis

UNIT SIZE
 09 24
 12 30
 15 36
 18

VOLTAGE
 E = 265-60-1
 G = 208/230-60-1

CONTROLS & MOTORS

Controls	Motor			
	PSC	EC CT	EC CV	N/A
24V	-	-	-	A
Electro-Mechanical	-	-	-	B
Line-Voltage	-	-	-	C
CXM2	D	F	-	-
DXM2.5	E	G	J	-

OPTIONS

Option	Stainless Steel Drain Pan	UltraQuiet
S	-	-
A	X	-
1	-	X
2	X	X

REVISION
 A = Current Revision

FUTURE
 A = Not Used

OTHER OPTIONS
 A = Standard
 M = MPC

HEAT EXCHANGER OPTIONS

C = Copper Coax with Non-Coated Air Coil
 N = Copper Coax with Non-Coated Air Coil & Insulated Tubing

WATER VALVE & PUMP OPTIONS

S = No Water Valve
 M = Standard Water Valve (Fail Closed)
 N = Standard Water Valve (Fail Open)
 P = Internal Secondary Pump
 G = Standard 3-way Water Valve
 T = Modulating Water Valve
 H = Hydronic Heating with Standard Water Valve (Fail Closed)
 J = Hydronic Heating with Standard Water Valve (Fail Open)
 L = Hydronic Heating with 3-Way Water Valve

CONTROLS OPTIONS

	RA Sensors	Communicating Thermostat	RIB Relay
S	-	-	-
A	X	-	-
B	-	X	-
C	-	-	X
D	-	X	X

AUTO-FLOW REGULATOR (US GPM) CODE

Option	09	12	15	18	24	30	36		
0	NO FLOW REGULATOR								
C	1.5								
D	2.0								
E	2.5								
F		3.0							
G		3.5							
H			4.0						
J				5.0					
K					6.0				
L						7.0			
M							8.0		
N								9.0	
P									10.5

Models:
MH
09-36

Attentions, Cautions, and Warnings

SAFETY

Warnings, cautions, and notices appear throughout this manual. Read these items carefully before attempting any installation, service, or troubleshooting of the equipment.

DANGER: Indicates an immediate hazardous situation, which if not avoided will result in death or serious injury. DANGER labels on unit access panels must be observed.

WARNING: Indicates a potentially hazardous situation, which if not avoided could result in death or serious injury.

CAUTION: Indicates a potentially hazardous situation or an unsafe practice, which if not avoided could result in minor or moderate injury or product or property damage.

NOTICE: Notification of installation, operation, or maintenance information, which is important, but which is not hazard-related.

WARNING



Disconnect power supply(ies) before servicing. Refer servicing to qualified service personnel. Electric shock hazard. May result in injury or death!

WARNING

To avoid the release of refrigerant into the atmosphere, the refrigerant circuit of this unit must be serviced only by technicians who meet local, state, and federal proficiency requirements.

WARNING

The installation of water-source heat pumps and all associated components, parts, and accessories which make up the installation shall be in accordance with the regulations of ALL authorities having jurisdiction and MUST conform to all applicable codes. It is the responsibility of the installing contractor to determine and comply with ALL applicable codes and regulations.

WARNING

The appliance shall be stored in a room without continuously operating ignition sources (for example: open flames, an operating gas appliance or an operating electric heater).

WARNING

If unit connected via an air duct system to one or more rooms with R-454B is installed in a room with an area less than A_{min} or has an Effective Dispersal Volume less than minimum, that room shall be without continuously operating open flames or other POTENTIAL IGNITION SOURCES. A flame-producing device may be installed in the same space if the device is provided with an effective flame arrest.

WARNING

All refrigerant discharged from this unit must be recovered WITHOUT EXCEPTION. Technicians must follow industry accepted guidelines and all local, state, and federal statutes for the recovery and disposal of refrigerants. If a compressor is removed from this unit, refrigerant circuit oil will remain in the compressor. To avoid leakage of compressor oil, refrigerant lines of the compressor must be sealed after it is removed.

WARNING

This appliance is not intended for use by persons (including children) with reduced physical, sensory, or mental capabilities, or lack of experience and knowledge, unless they have been given supervision or instruction concerning use of the appliance by a person responsible for their safety.

WARNING

An unventilated area where the appliance using FLAMMABLE REFRIGERANTS is installed shall be so constructed that should any refrigerant leak, it will not stagnate so as to create a fire or explosion hazard.

WARNING

Auxiliary devices which may be a POTENTIAL IGNITION SOURCE shall not be installed in the duct work. Examples of such POTENTIAL IGNITION SOURCES are hot surfaces with a temperature exceeding 1,292°F (700°C)

WARNING

An unventilated area where a water source heat pump is installed and surpasses a R-454B refrigerant charge of 62 oz (1.76 kg), shall be without continuously operating open flames (for example an operating gas appliance) or other POTENTIAL IGNITION SOURCES (for example, an operating electric heater, hot surfaces).

WARNING

Only auxiliary electric heaters approved by ClimateMaster shall be installed in connecting ductwork. The installation of any other auxiliary devices is beyond ClimateMaster's responsibility.

WARNING

For mechanical ventilation, the lower edge of the air extraction opening where air is exhausted from the room shall not be more than 3.94 inches (100 mm) above the floor. The location where the mechanical ventilation air extracted from the space is discharged shall be separated by a sufficient distance, but not less than 9.84 feet (3 m), from mechanical ventilation air intake openings, to prevent recirculation to the space.

WARNING

Children being supervised are NOT to play with the appliance.

WARNING

Do not pierce or burn.

WARNING

Be aware that refrigerants may not contain odor.

Attentions, Cautions, and Warnings

CAUTION

DO NOT store or install units in corrosive environments or in locations subject to temperature or humidity extremes (e.g., attics, garages, rooftops, etc.). Corrosive conditions and high temperature or humidity can significantly reduce performance, reliability, and service life. Always move and store units in an upright position. Tilting units on their sides will cause equipment damage.

CAUTION

CUT HAZARD - Failure to follow this caution may result in personal injury. Sheet metal parts may have sharp edges or burrs. Use care and wear appropriate protective clothing, safety glasses and gloves when handling parts and servicing heat pumps.

CAUTION

To avoid equipment damage, DO NOT use these units as a source of heating or cooling during the construction process. The mechanical components and filters can quickly become clogged with construction dirt and debris, which may cause system damage and void product warranty.

CAUTION

All three phase scroll compressors must have direction of rotation verified at startup. Verification is achieved by checking compressor Amp draw. Amp draw will be substantially lower compared to nameplate values. Additionally, reverse rotation results in an elevated sound level compared to correct rotation. Reverse rotation will result in compressor internal overload trip within several minutes. Verify compressor type before proceeding.

NOTICE

Servicing shall be performed only as recommended by the manufacturer.

NOTICE

REFRIGERANT SENSORS for REFRIGERANT DETECTION SYSTEMS shall only be replaced with sensors specified by the appliance manufacturer.

NOTICE

An unconditioned attic is not considered natural ventilation.

NOTICE

Maximum external statics must be adhered to in order to maintain minimum CFM.

NOTICE

LEAK DETECTION SYSTEM installed. Unit must be powered except for service.

Models:
MH
09-36

General Information

INSPECTION

Upon receipt of the equipment, carefully check the shipment against the bill of lading. Make sure all units have been received. Inspect the packaging of each unit, and inspect each unit for damage. Ensure that the carrier makes proper notation of any shortages or damage on all copies of the freight bill and completes a common carrier inspection report. Concealed damage not discovered during unloading must be reported to the carrier within 15 days of receipt of shipment. If not filed within 15 days, the freight company can deny the claim without recourse.

NOTE: It is the responsibility of the purchaser to file all necessary claims with the carrier. Notify your equipment supplier of all damage within 15 days of shipment.

STORAGE

Equipment should be stored in its original packaging in a clean, dry area. Store chassis in an upright position at all times. Stack units at a maximum of 2 units high.

UNIT PROTECTION

Cover units on the job site with either the original packaging or an equivalent protective covering. Cap the open ends of pipes stored on the job site. In areas where painting, plastering, and/or spraying has not been completed, all due precautions must be taken to avoid physical damage to the units and contamination by foreign material. Physical damage and contamination may prevent proper startup and may result in costly equipment clean-up.

Examine all pipes, fittings, and valves before installing any of the system components. Remove any dirt or debris found in or on these components.

Prior to flushing risers with water, be sure that the temperature in building will always be above freezing.

PRE-INSTALLATION

Installation, Operation, and Maintenance instructions are provided with each unit. The installation site chosen should include adequate service clearance around the unit. Before unit startup, read all manuals and become familiar with the unit and its operation. Thoroughly check the system before operation. Thoroughly check the system before operation. Check that you have all kits and options required before starting. **Verify electrical service to cabinet is adequate for new chassis. See electrical data. Upgrade service if it is needed.**

PREPARE CHASSIS FOR INSTALLATION AS FOLLOWS:

1. Verify refrigerant tubing is free of kinks or dents and that it does not touch other unit components.
2. Inspect all electrical connections. Connections must be clean and tight at the terminals.
3. Remove compressor shipping clips, bracket, or screws. See chassis pre-installation section for instructions.
4. If chassis is not installed in cabinet, store in original carton.

CAUTION

DO NOT store or install units in corrosive environments or in locations subject to temperature or humidity extremes (e.g., attics, garages, rooftops, etc.). Corrosive conditions and high temperature or humidity can significantly reduce performance, reliability, and service life. Always move and store units in an upright position. Tilting units on their sides will cause equipment damage.

CAUTION

CUT HAZARD - Failure to follow this caution may result in personal injury. Sheet metal parts may have sharp edges or burrs. Use care and wear appropriate protective clothing, safety glasses and gloves when handling parts and servicing heat pumps.

CHECKS TO THE AREA

Prior to beginning work on systems containing FLAMMABLE REFRIGERANTS, safety checks are necessary to ensure that the risk of ignition is minimized. For repair to the REFRIGERATING SYSTEM, these steps shall be completed prior to conducting work on the system.

General Information

Work Procedure

Work shall be undertaken following a controlled procedure so as to minimize the risk of a flammable gas or vapor being present while the work is being performed.

General Work Area

All maintenance staff and others working in the local area shall be instructed on the nature of work being carried out. Work in confined spaces shall be avoided.

Checking for presence of refrigerant

The area shall be checked with an appropriate refrigerant detector prior to and during work, to ensure the technician is aware of potentially toxic or flammable atmospheres. Ensure that the leak detection equipment being used is suitable for use with all applicable refrigerants, i.e. non-sparking, adequately sealed or intrinsically safe.

Presence of fire Extinguisher

If any hot work is to be conducted on the refrigeration equipment or any associated parts, appropriate fire extinguishing equipment shall be available to hand. Have a dry powder or CO₂ fire extinguisher adjacent to the charging area.

No ignition sources

No person carrying out work in relation to a REFRIGERATION SYSTEM which involves exposing any pipe work shall use any sources of ignition in such a manner that it may lead to the risk of fire or explosion. All possible ignition sources, including cigarette smoking, should be kept sufficiently far away from the site of installation, repairing, removing and disposal, during which refrigerant can possibly be released to the surrounding space. Prior to work taking place, the area around the equipment is to be surveyed to make sure that there are no flammable hazards or ignition risks. "No Smoking" signs shall be displayed.

Ventilated area

Ensure that the area is in the open or that it is adequately ventilated before breaking into the system or conducting any hot work. A degree of ventilation shall continue during the period that the work is carried out. The ventilation should safely disperse any released refrigerant and preferably expel it externally into the atmosphere.

Checks to the Refrigeration Equipment

The following checks shall be applied to installations using FLAMMABLE REFRIGERANTS:

- The actual REFRIGERANT CHARGE is in accordance with the room size within which the refrigerant containing parts are installed;
- The ventilation machinery and outlets are operating adequately and are not obstructed;
- If an indirect refrigerating circuit is being used, the secondary circuit shall be checked for the presence of refrigerant;
- Marking to the equipment continues to be visible and legible. Markings and signs that are illegible shall be corrected;
- Refrigerant piping or components are installed in a position where they are unlikely to be exposed to any substance which may corrode refrigerant containing components, unless the components are constructed of materials which are inherently resistant to being corroded or are suitably protected against being so corroded.

Checks to Electrical Devices

Repair and maintenance to electrical components shall include initial safety checks and component inspection procedures. If a fault exists that could compromise safety, then no electrical supply shall be connected to the circuit until it is satisfactorily dealt with. If the fault cannot be corrected immediately but it is necessary to continue operation, an adequate temporary solution shall be used. This shall be reported to the owner of the equipment so all parties are advised.

Initial safety checks shall include:

- Capacitors are discharged: this shall be done in a safe manner to avoid possibility of sparking;
- That no live electrical components and wiring are exposed while charging, recovering, or purging the system;
- That there is continuity of earth bonding.

Refrigerant System Servicing

REFRIGERANT SYSTEM

To maintain sealed circuit integrity, do not install service gauges unless unit operation appears abnormal. Reference the operating charts for pressures and temperatures. Verify that air and water flow rates are at proper levels before servicing the refrigerant circuit.

Removal and Evacuation

When breaking into the refrigerant circuit to make repairs - or for any other purpose - conventional procedures shall be used. However, for flammable refrigerants it is important that best practice be followed, since flammability is a consideration. The following procedure shall be adhered to:

- Safely remove refrigerant following local and national regulations
- Evacuate
- Purge the circuit with Inert gas
- Evacuate
- Continuously flush or purge with Inert gas when using flame to open circuit
- Open the circuit.

The refrigerant charge shall be recovered into the correct recovery cylinders. For appliances containing flammable refrigerants, the system shall be purged with oxygen-free nitrogen to render the appliance safe. This process might need to be repeated several times. Compressed air or oxygen shall not be used for purging refrigerant systems.

For appliances containing flammable refrigerants, refrigerant purging shall be achieved by breaking the vacuum in the system with oxygen-free nitrogen and continuing to fill until the working pressure is achieved, then venting to atmosphere, and finally pulling down to a vacuum (optional for FLAMMABLE REFRIGERANT). This process shall be repeated until no refrigerant remains in the system (optional for FLAMMABLE REFRIGERANT). When the final oxygen-free nitrogen charge is used, the system shall be vented down to atmospheric pressure to enable work to take place.

The outlet for the vacuum pump shall not be close to any potential ignition sources, and ventilation shall be available.

Charging Procedures

In addition to conventional charging procedures, the following requirements shall be followed:

- Ensure that contamination of different refrigerants does not occur when using charging equipment.
- Hoses or lines shall be as short as possible to minimize the amount of refrigerant contained in them.
- Cylinders shall be kept in an appropriate position according to the instructions.
- Ensure that the REFRIGERATION SYSTEM is earthed prior to charging the system with refrigerant.
- Label the system when charging is complete (if not already).
- Extreme care shall be taken not to overfill the REFRIGERATION SYSTEM.

Prior to recharging the system, it shall be pressure-tested with the appropriate purging gas. The system shall be leak-tested on completion of charging but prior to commissioning. A follow up leak test shall be carried out prior to leaving the site.

Leak Detection

Under no circumstances shall potential sources of ignition be used in the searching for or detection of refrigerant leaks. A halide torch (or any other detector using a naked flame) shall not be used.

The following leak detection methods are deemed acceptable for all refrigerant systems.

Electronic leak detectors may be used to detect refrigerant leaks but, in the case of FLAMMABLE REFRIGERANTS, the sensitivity may not be adequate, or may need re-calibration. (Detection equipment shall be calibrated in a refrigerant-free area.) Ensure that the detector is not a potential source of Ignition and is suitable for the refrigerant used. Leak detection equipment shall be set at a percentage of the lower flammability limit of the refrigerant and shall be calibrated to the refrigerant employed, and the appropriate percentage of gas (25% maximum) is confirmed.

Refrigerant System Servicing

Leak detection fluids are also suitable for use with most refrigerants but the use of detergents containing chlorine shall be avoided as the chlorine may react with the refrigerant and corrode the copper pipe-work.

NOTE:

Examples of leak detection fluids are:

- Bubble method
- Fluorescent method agents

If a leak is suspected, all naked flames shall be removed/extinguished.

If a refrigerant leak that requires brazing is identified, all of the refrigerant shall be recovered from the system, or isolated (by means of shut off valves) in a part of the system remote from the leak. Removal of refrigerant shall be according to Removal and Evacuation section.

DECOMMISSIONING

Before carrying out this procedure, it is essential that the technician is completely familiar with the equipment and all its detail. It is recommended good practice that all refrigerants are recovered safely. Prior to the task being carried out, an oil and refrigerant sample shall be taken in case analysis is required prior to re-use of recovered refrigerant. It is essential that electrical power is available before the task is commenced.

1. Become familiar with the equipment and its operation.
2. Isolate system electrically.
3. Before attempting the procedure, ensure that:
 - Mechanical handling equipment is available, if required, for handling refrigerant cylinders.
 - All personal protective equipment is available and being used correctly.
 - The recovery process is supervised at all times by a competent person.
 - Recovery equipment and cylinders conform to the appropriate standards.
4. Pump down refrigerant system, if possible.

5. If a vacuum is not possible, make a manifold so that refrigerant can be removed from various parts of the system.
6. Make sure that cylinder is situated on the scales before recovery takes place.
7. Start the recovery machine and operate in accordance with instructions.
8. Do not overfill cylinders (no more than 80 % volume liquid charge).
9. Do not exceed the maximum working pressure of the cylinder, even temporarily.
10. When the cylinders have been filled correctly and the process completed, make sure that the cylinders and the equipment are removed from site promptly and all isolation valves on the equipment are closed off.
11. Recovered refrigerant shall not be charged into another REFRIGERATING SYSTEM unless it has been cleaned and checked.

Labeling - Upon decommissioning, equipment shall be labeled stating that it has been decommissioned and emptied of refrigerant. The label shall be dated and signed.

RECOVERY

When removing refrigerant from a system, either for servicing or decommissioning, it is recommended good practice that all refrigerants are removed safely.

When transferring refrigerant into cylinders, ensure that only appropriate refrigerant recovery cylinders are employed. Ensure that the correct number of cylinders for holding the total system charge is available. All cylinders to be used are designated for the recovered refrigerant and labeled for that refrigerant (i.e. special cylinders for the recovery of refrigerant). Cylinders shall be complete with pressure-relief valve and associated shut-off valves in good working order. Empty recovery cylinders are evacuated and, if possible, cooled before recovery occurs.

The recovery equipment shall be in good working order with a set of instructions concerning the equipment that is at hand and shall be suitable for the recovery of the flammable refrigerant. If in doubt, the manufacturer should be consulted.

Models:
MH
09-36

Refrigerant System Servicing

In addition, a set of calibrated weighing scales shall be available and in good working order. Hoses shall be complete with leak-free disconnect couplings and in good condition.

The recovered refrigerant shall be processed according to local legislation in the correct recovery cylinder, and the relevant waste transfer note arranged. Do not mix refrigerants in recovery units and especially not in cylinders.

If compressors or compressor oils are to be removed, ensure that they have been evacuated to an acceptable level to make certain that flammable refrigerant does not remain within the lubricant. The compressor body shall not be heated by an open flame or other ignition sources to accelerate this process. When oil is drained from a system, it shall be carried out safely.

Existing Chassis R-454B MH Replacement Models

816 to MH8 Replacement

Old Chassis	New Chassis
*81610	MH8 09
*81615	MH8 12
*81620	MH8 18
*81628	MH8 24
*81630	MH8 30
*81636	MH8 36

* A hose adapter kit is required for replacement if the existing 816 chassis is revision A-L. See Hose Adapter Part Numbers table for reference.

817 to MH8 Replacement

Old Chassis	New Chassis
81709	MH8 09
81712	MH8 12
81724	MH8 24
81730	MH8 30
81736	MH8 36

TSM/TSL 09-12 Rev. A-B to MHM/MHS Replacement

Old Chassis	New Chassis
TSM/TSL09 (Rev. A-B)	MHM/MHS 09
TSM/TSL12 (Rev. A-B)	MHM/MHS 12

TRM to MHR Replacement

Old Chassis	New Chassis
TRM09	MHR 09
TRM12	MHR 12
TRM15	MHR 15
TRM18	MHR 18
TRM24	MHR 24
TRM30	MHR 30
TRM36	MHR 36

TSM/TSL 09-12 Rev C and TSM/TSL 15-36 Rev A-C to MHC/MHD Replacement

Old Chassis	New Chassis
TSM/TSL09 (Rev. C)	MHC/MHD 09
TSM/TSL12 (Rev. C)	MHC/MHD 12
TSM/TSL15 (Rev. A-C)	MHC/MHD 15
TSM/TSL18 (Rev. A-C)	MHC/MHD 18
TSM/TSL24 (Rev. A-C)	MHC/MHD 24
TSM/TSL30 (Rev. A-C)	MHC/MHD 30
TSM/TSL36 (Rev. A-C)	MHC/MHD 36

Hose Adapter Part Numbers (applies when replacing existing 816 chassis Rev A-L only)

Existing chassis series and size	Replacement Series	Hose Adapter Part Number (required)	Hose Kit Part Number (optional)
81610-15 (rev A-L)	MH809-12	29S0019N01	AHH05024SC
*81620 (rev A-L)	MH818	29S0019N02	AHH07536SC
81628 (rev A-L)	MH824	29S0019N07	AHH10036SC
81630-36 (rev A-L)	MH830-36	29S0019N08	AHH10036SC

* All MH818 replacement chassis ship with hose adapter 29S0019N02 as standard.

Models:
MH
09-36

R-454B Chassis Conversions and Compatibility

Field Conversion Series Compatibility

Legacy Chassis Series	R-454B Chassis Series	Potential Field Conversion	Are components required for this conversion?
TRM 09/12	MH809/12 (P controls only)	MHR09/12	All MH809/12 are shipped with a conversion block. When replacing a TRM 09/12, the conversion block should be kept on the MH809/12 chassis.
TRM 18	MH818 (P controls only)	MHR18	No. Standard configuration of both chassis are interchangeable if the MH8 has P controls.
TRM 24/30/36	MH824/30/36 (P controls only)	MHR24/30/36	
816 & 817 09/12	MHR09/12	MH809/12 (P controls only)	No parts required. The Block off shipped with MHR09/12 is removed and the chassis is interchangeable with MH809/12 chassis.
816 & 817 18/20	MHR18	MH818 (P controls only)	Yes. The MH818 accessory block-off accessory is required. The block-off accessory ships with the MH818 chassis and may be ordered separately.*
816 & 817 24/30/36	MHR24/30/36	MH824/30/36 (P controls only)	No parts required.
TSM Rev. A/B 9/12	MHM09/12	MHS09/12	No. TSM and TSL are interchangeable if the legacy installed chassis does not have features specific to that series. The series will need to be reconfigured on the communicating unit controller with service tool to function properly.
TSL Rev. A/B 9/12	MHS09/12	MHM09/12	
TSM Rev. C 9-36	MHC09-36	MHD09-36	
TSL Rev. C 9-36	MHD09-36	MHC09-36	

Notes:

- * This conversion only occurs if a R-454B MHR18 is replacing a 81620 chassis in the field.
- All options/features on the R-454B chassis should be verified before converting to another series to ensure the R-454B chassis is a compatible replacement.
- 816 products were offered with line voltage, electro-mechanical, and P-controls. The oldest of those were the line voltage and electro-mechanical options. For direct replacement of 816 chassis with line voltage or electro-mechanical controls, the MH8 series chassis must be used (cannot be field converted). Please consult the 816/817 and MH model nomenclature to determine the controls option.

816-817 to MH8/MHR Conversion Data

816 Chassis		R-454B Replacement Chassis			
Digits 1-5	Digit 8	Without Cabinet Kit		With Cabinet Kit	
		Digits 1-5	Digit 7	Digits 1-5	Digit 7
81610	S	MH809	C	MH8/R09	A
	M		B		
	P	MH8/R09	A		
81612	S	MH812	C	MH8/R12	A
	M		B		
	P	MH8/R12	A		
81620	S	MH818	C	MH8/R18	A
	M		B		
	P	MH8/R18	A		
81628	S	MH824 or 30	C	MH8/R24 or 30	A
	M		B		
	P	MH8/R24 or 30	A		
81630	S	MH830	C	MH8/R30	A
	M		B		
	P	MH8/R30	A		
81636	S	MH836	C	MH8/R36	A
	M		B		
	P	MH8/R36	A		

816-817 Controls to MH8 Controls Conversion

816-817 controls option	MH8 controls options
P- Standard (24V N.C. safeties) for use with CXM2 or DXM2.5	A-24V
M-Combination Controls	B-Electro-Mechanical
S-Standard (line voltage) 115V controls	C-Line-Voltage

Existing Chassis to Replacement MH Series Water Connection Dimensions Chart

Models:
MH
09-36

Existing Chassis Water Connection Sizes 816 to MH8

Existing Chassis		Replacement Chassis	
Model	Water Connection Size	Model	Water Connection Size
*81610	1/2"	MH809	1/2"
*81615		MH812	
*81620		**MH818	3/4"
*81628	3/4"	MH824	1"
*81630		MH830	
*81636		MH836	

817 to MH8

Existing Chassis		Replacement Chassis	
Model	Water Connection Size	Model	Water Connection Size
81709	1/2"	MH809	1/2"
81712		MH812	
81724	1"	MH824	1"
81730		MH830	
81736		MH836	

*All 816 chassis revision A-L require hose adapters be ordered upon replacement. See the hose adapter table below for which part numbers should be ordered at each size.

**All SH818 chassis ship with 1/2" to 3/4" hose adapter

TRM to MHR

Existing Chassis		Replacement Chassis	
Model	Water Connection Size	Model	Water Connection Size
TRM09	1/2"	MHR09	1/2"
TRM12		MHR12	
TRM15	3/4"	MHR15	3/4"
TRM18		MHR18	
TRM24	1"	MHR24	1"
TRM30		MHR30	
TRM36		MHR36	

TSM/L to MHM/S/C/D

Existing Chassis*		Replacement Chassis	
Model	Water Connection Size	Model	Water Connection Size
TSM/L09	1/2"	MHM/S/C/D09	1/2"
TSM/L12		MHM/S/C/D12	
TSM/L15	3/4"	MHM/S/C/D15	3/4"
TSM/L18		MHM/S/C/D18	
TSM/L24	1"	MHM/S/C/D24	1"
TSM/L30		MHM/S/C/D30	
TSM/L36		MHM/S/C/D36	

* All revisions

Hose Adapter Part Numbers

(applies when replacing existing 816 chassis Rev A-L only)

Existing chassis series and size	Replacement Series	Hose Adapter Part Number (required)	Hose Kit Part Number (optional)
81610-15 (rev A-L)	MH809-12	29S0019N01	AHH05024SC
*81620 (rev A-L)	MH818	29S0019N02	AHH07536SC
81628 (rev A-L)	MH824	29S0019N07	AHH10036SC
81630-36 (rev A-L)	MH830-36	29S0019N08	AHH10036SC

* All MH818 replacement chassis ship with hose adapter 29S0019N02 as standard.

Models:
MH
09-36

Chassis Pre-installation and Chassis Installation MH8 (816-817 replacement)

CAUTION

All work must be performed by a licensed service technician.

WARNING

Disconnect and lockout electrical power to cabinet.

CABINET PRE-INSTALLATION OF CHASSIS

1. Shutoff and lockout unit power at main panel.
2. Close water shutoffs, disconnect hoses at chassis.
3. Disconnect electrical connection to chassis.
4. When installing an MH8 chassis with control option code P go to the cabinet control box to verify the presence of a blue wire between pin 4 of the twelve-pin quick connector and pin 2 of the nine-pin quick connector. If this wire is not present add it prior to unit startup. Two blue wires are provided in the bag containing the unit installation manual. Select the blue wire that has the appropriate connectors on both ends to mate with the 12- and nine-pin quick connectors. Discard the unused blue wire. See this on the unit wiring diagram.
5. Remove old chassis.
6. Model 81620 chassis require the sheet metal block off, shipped with the MH818 replacement chassis, to be applied to the existing size 20 cabinet for a compatible replacement.

CAUTION

CLIMATEMASTER IS NOT RESPONSIBLE OR LIABLE FOR ANY DAMAGE DUE TO WATER LEAKS

7. 816 style cabinets with "P" style controls only require a wire harness conversion kit. 816 style cabinets with "P" controls were offered with a singular 9-pin harness and utilized a gray FP1 thermistor for freeze protection in heating mode only. The later generation cabinets introduced a 6-pin wire harness combined with a 9-pin harness which added a violet FP2 thermistor for freeze protection during both heating and cooling modes of operation. The S11S0084N01 controls conversion kit includes a combination 12-/9-/6-pin wire harness and violet FP2 thermistor which is compatible with the current MH8 replacement chassis with "P" controls. See wire diagram that comes with the S11S0084N01 for details on installation of the conversion wire harness.
8. 816 Chassis revisions M and higher have hose connections. Revisions A-L have hard unions and water connection must be reworked for hose connection. Use adapter kit 29S0019 series or repipe using new ball valve shutoffs. Any new piping cannot interfere with chassis.

Note: Any water tubing modifications behind shutoff require a draining riser. Pressure test before refilling water.
9. Attach hoses, NPT threaded end to cabinet.
10. Some high-voltage cabinets require a wire harness (shipped with chassis). Open the control box to connect, then run wires through grommeted hole in bottom of box, quick-connector end hanging down. Close the electrical box.

Note: Old A-Mode style electrical connectors should not be reused.
11. Cabinets that controls were changed require low-voltage thermostat. Also old cabinets that energized RV for heating and new replacement has RV for cooling require a thermostat to send O signal. Replace the thermostat if required.
12. Clean interior of cabinet.
13. Check drain pan is draining freely.

Chassis Pre-installation and Chassis Installation MH8 (816-817 replacement)

Models:
MH
09-36

CHASSIS PRE-INSTALLATION

1. Check chassis data plate. Verify chassis is correct (Both size and voltage) for cabinet by referencing the Existing Chassis to Replacement Chassis Conversions.
2. Check for any shipping or handling damage. Make repairs or adjustments.
3. Verify refrigerant tubing is free of kinks or dents and that it does not touch other unit components.
4. Inspect all electrical connections. Connections must be clean and tight at the terminals.
5. If your model has 24V motorized water valve, locate black wire from wire nut, remove plastic covering from terminal and push into position 6 of 9-pin quick connector. (See View A).
6. Install hose adaptor kit (ships with chassis) if required.

CHASSIS INSTALLATION

1. Position chassis partway into cabinet.
2. Connect hoses, swivel end to chassis. Check washer is inside swivel hand tighten.
3. Purge air (if model has motorized water valve - manually open) from chassis. Hand tighten hoses plus $\frac{1}{8}$ turn.
4. Slide into cabinet. Do not pinch hoses, adjust if required.
5. Connect electrical quick connector. 1, 2, or 3, depending on your model.
6. Open both water shutoffs. Check for any water leaks. Repair if needed
7. Attach upper blockoff. Blockoff should overlap air coil so no air can bypass coil. Seal if required.
8. Turn on electrical power.
9. Check unit operation.
10. Reinstall front panel. Panel or chassis sheet metal may require field modifications for attaching.

View A:

**Female end of
9-pin quick connector
(Not all wires are shown.)**

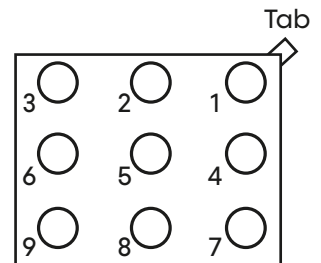

Models:
MH
09-36

Chassis Pre-Installation MHM/MHS/MHC/MHD (TSM/TSL replacement)

See Figures 1-4:

1. Check chassis data plate. Verify chassis is correct for the cabinet. Chassis I.D. sticker should match sticker on cabinet-blower housing.
 - a. Verify refrigerant tubing is free of kinks or dents, and that it does not touch other tubes or unit parts as it passes over or through. Adjust if needed and separate with closed-cell insulation.
 2. Remove compressor cover, check for any shipping or handling damage. Make repairs or adjustments.
 - b. Inspect insulation inside compressor enclosure for rubs from tubing or reversing valve. Adjust tubing or RV inward if needed. Be careful not to cause contact somewhere else.
 3. Inspect all electrical connections. Connections must be clean and tight at the terminals.
 4. Replace any panels or covers removed for steps 2-4.
- The chassis is now ready for installation. Always keep chassis upright.

Figure 1: Front

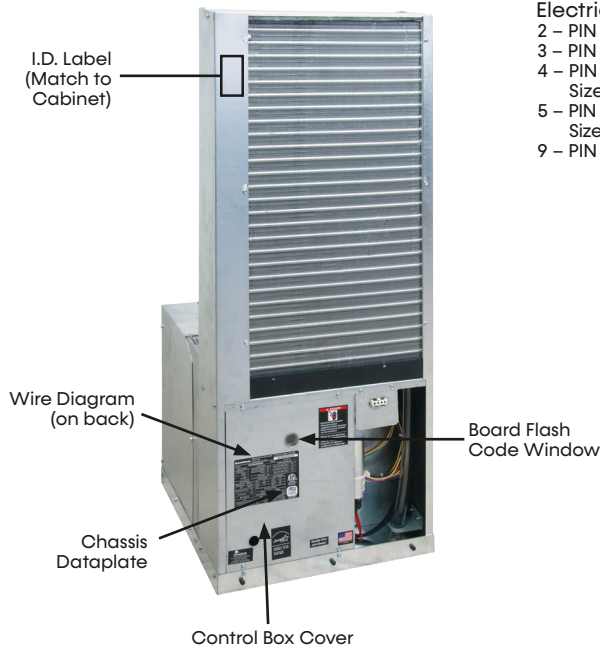

Figure 2: Back

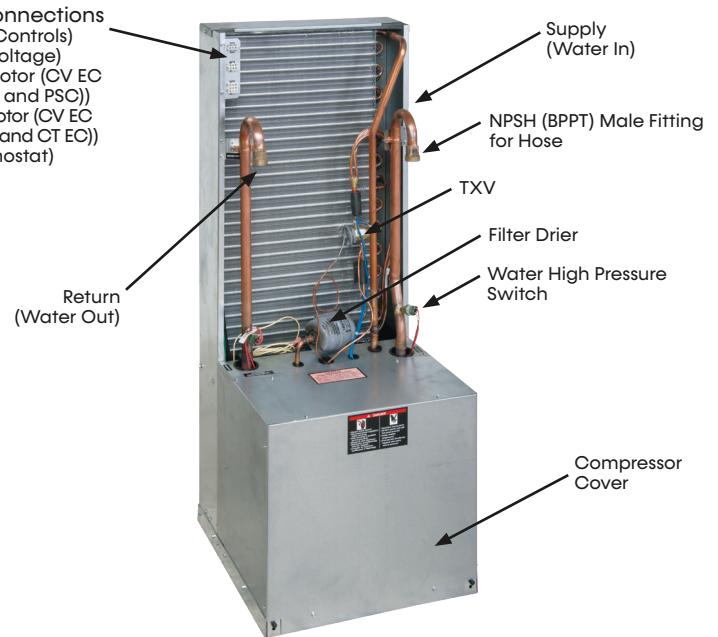

Figure 3: Control Box Cover Removed

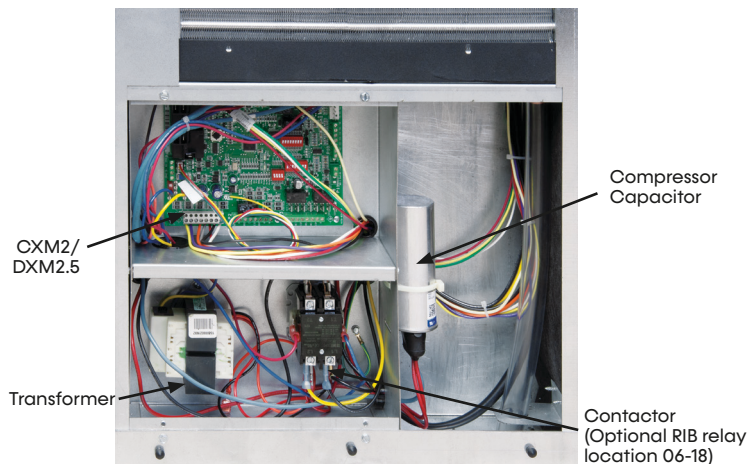
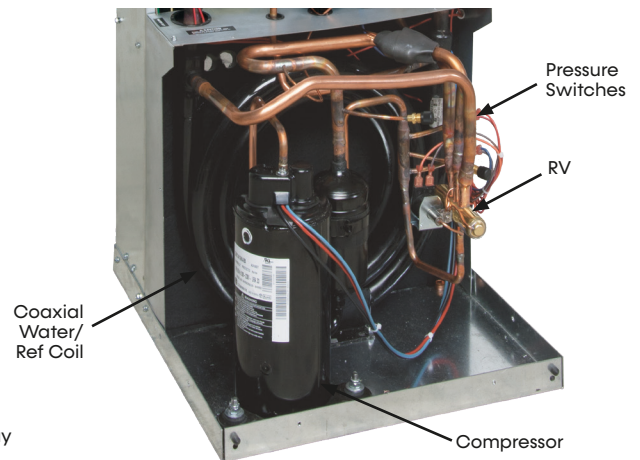

Figure 4: Enclosure Removed



Hose Kit and Chassis Installation MHM/MHS/MHC/MHD (TSM/TSL replacement)

Models:
MH
09-36

HOSE KIT AND CHASSIS INSTALLATION

After cabinets are installed, and walls finished remove the filter and front blockoff panel. **SAVE THESE FOR RE-INSTALLATION AFTER THE CHASSIS IS INSTALLED!**

Step 1: Remove filter and inner panel (Figure 5). For chassis shipped in cabinet, remove and discard four shipping bolts.

Figure 5: Front

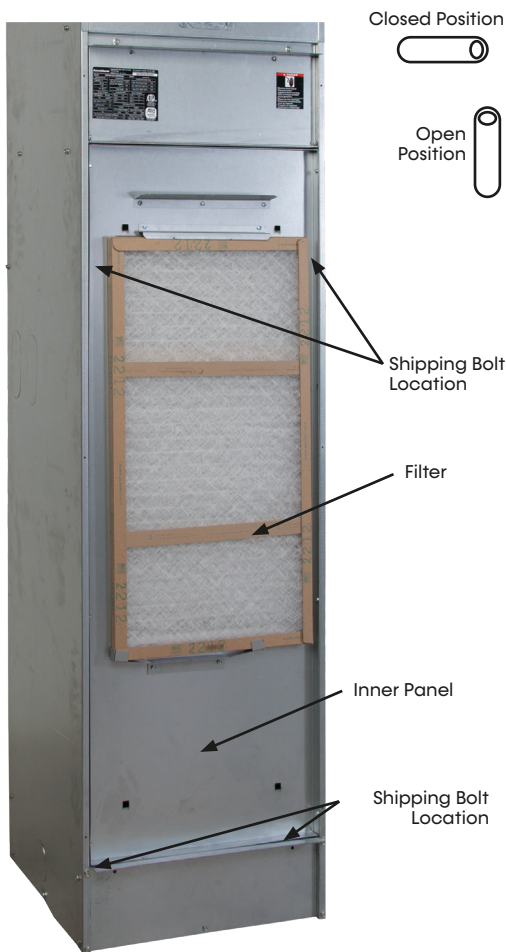

Step 2: Attach the Flex Hoses to shutoffs in the cabinet. Unpack and examine hose kit. Remove all shipping and/or packing material such as rubber bands, plastic caps, and styrofoam. Hose kit should contain two (2) hoses.

CAUTION

If the risers are under pressure, do not open shut off valves until installation is complete!

Figure 6: Return and Supply Shutoff Location (Cabinet Style 2 Riser Back Left)

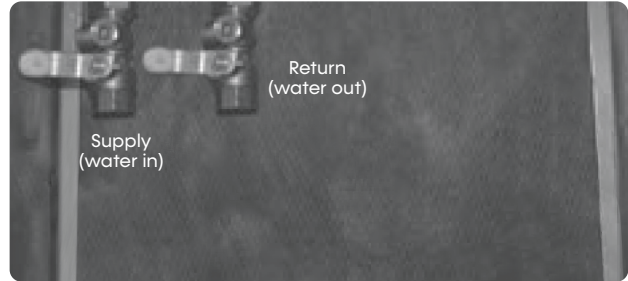

WARNING

Do Not Remove valve or loosen valve-union nut without first draining the risers below cabinet level. Check with contractor if risers have water.

WARNING

Under no circumstances should any part of the hose itself be gripped or twisted by hand, pliers, channel locks or any other tool. Leakage or bursting may occur! Wrenches are used on pipe threads only. Hand tighten swivel connections.

AHU HOSE

Locate the two shutoff valves inside the unit cabinet (Figure 6). Supply (water in) is always closest to corner). Check to see if swivel ends have washer inside them (Figure 7). Attach the hoses to the water valves.

NOTE: Make sure the valve handles are in a position that enables them to be fully opened and closed.

Figure 7: AHU Hoses

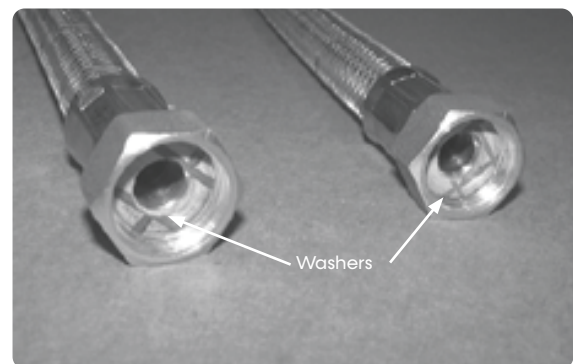

Table 1: Metal Hose Minimum Bend Radii

Hose Diameter	Minimum Bend Radii
1/2" [12.7 mm]	2-1/2" [6.4 cm]
3/4" [19.1 mm]	4" [10.2 cm]
1" [25.4 mm]	5-1/2" [14 cm]
1-1/4" [31.8 mm]	6-3/4" [17.1 cm]

Models:
MH
09-36

Hose Kit and Chassis Installation MHM/MHS/MHC/MHD (TSM/TSL replacement)

Step 3: Attach AHU hoses to the Chassis. Check the swivel ends of the hoses (Figure 7). Washers must be in the hose for water tight connection. Slide the chassis part way into the cabinet. Match the WATER IN (supply) hose to the WATER IN tube on the chassis and the WATER OUT (Return) hose to the WATER OUT tube. Position hose toward chassis, use gentle loop-see bend radii Table 1 on page 17. Hand-tighten the hose.

Do not bend hoses at less than the minimum bend radius for the hose selected. Less than the minimum bend radius may cause the hose to collapse, which reduces water flow rate. Install an angle adapter to avoid sharp bends in the hose when the radius falls below the required minimum.

- ⚠ CAUTION**

Do not bend or kink supply lines or hoses.
- ⚠ CAUTION**

Piping must comply with all applicable codes.
- ⚠ CAUTION**

Corrosive system water requires corrosion resistant fittings and hoses, and may require water treatment.
- ⚠ WARNING**

Under no circumstances should any part of the hose itself be gripped or twisted by hand, pliers, channel locks or any other tool. Leakage or bursting may occur! Always use a back-up wrench when tightening the hose.

Step 4: Chassis Installation - Check condensate pan is free and on four (4) rubber grommets.

Install the Chassis as follows:

1. Slide chassis fully into cabinet. Check hose for kinks, do not allow less than minimum bend radius (see Table 1 on page 17), pull chassis partway out, loosen hose and reposition hose if needed, re-tighten.
2. Verify that both the shut-off valves are closed. See Figure 6. (handle horizontal)
3. Verify riser stack has been pressure tested, and all leaks have been repaired.
4. Flush system following the procedure in Preparation for Startup Section of this manual.

- ⚠ WARNING**

Do Not open valves to chassis until system has flushed and purged of air!
- ⚠ NOTICE**

After the system has been filled and system pump is started, all connections should be rechecked for water leaks. MARS WILL NOT be responsible or liable for damage caused by water leaks at any field water connections!

5. When the system is clean and flushed, open both water shut off valves and check piping for leaks. Repair all leaks before continuing.
6. Complete electrical connections between cabinet and chassis. Connect wire harnesses hanging down from under side of control box to chassis connections. (See Figure 8). Check that quick connectors are snapped together, pull gently on connector - do not pull on wires.

Hose Kit and Chassis Installation MHM/MHS/MHC/MHD (TSM/TSL replacement)

Models:
MH
09-36

Figure 8: Chassis Connections



7. Before installing the inner panel and filter, perform the following checks:
 - h. Verify all pre-installation and installation steps were completed.
 - i. Verify all copper tubes do not touch or rub other tubes or parts of the unit.
 - j. Ensure that fan wheel rotates freely and does not rub against housing. If rough handling during shipping has caused fan wheel to shift, adjust as necessary.
 - k. Verify that water-piping connections to the chassis are complete and that unit service valves which were closed during flushing have been opened.
 - l. Verify that power between the cabinet and chassis is properly connected.
 - m. Ensure that the unit drain is properly positioned, secured, and not blocked.
 - n. Verify that the nuts used to secure the blower assembly to the fan deck are tight.
 - o. Check that chassis is fully inserted, front to back, side gap equal and chassis is centered in cabinet.
 - p. After the system is filled and system pump is started, all connections should be re-checked for water leaks. MARS WILL NOT be responsible or liable for damage caused by water leaks at any field water connections!

17. Re-attach the inner panel (8 screws) and filter as shown in the figure below. The chassis must free-float on condensate pan. If inner-panel holes do not align, push chassis further in.
18. Install the cabinet return-air panel after startup. See installation instructions shipped with return-air/access panel for detailed information.

Figure 9: Front Panel



Inner Panel

MARS (MH) VERTICAL STACK CHASSIS REPLACEMENT SERIES – IOM

Models:
MH
09-36

Electrical Data

Table 2: Electrical Data.

Size	Model	Voltage	Min/Max Voltage	Compressor			Pump	Branch Circuit Rating and Protection							
				MCC	RLA	LRA		FLA	No Pump			Internal Secondary Pump			
									Total Unit FLA	MCA	Max Fuse Size	Fuse HACR	Total Unit FLA	MCA	Max Fuse Size
09	MH8 / MHR	208/230-60-1	187/253	6.2	4.0	22.0	0.28	4.0	5.0	8.9	15	N/A	N/A	N/A	N/A
	MHM / MHS MHC / MHD											4.3	5.2	9.2	15
	MH8 / MHR	265-60-1	238/304	6.2	4.0	23.0	0.25	4.0	5.0	8.9	15	N/A	N/A	N/A	N/A
	MHM / MHS MHC / MHD											4.2	5.2	9.2	15
12	MH8 / MHR	208/230-60-1	187/253	7.2	4.6	25.0	0.49	4.6	5.8	10.4	15	N/A	N/A	N/A	N/A
	MHM / MHS MHC / MHD											5.1	6.3	10.9	15
	MH8 / MHR	265-60-1	238/304	6.1	3.9	21.0	0.33	3.9	4.9	8.8	15	N/A	N/A	N/A	N/A
	MHM / MHS MHC / MHD											4.2	5.2	9.1	15
15	MHR	208/230-60-1	187/253	8.1	5.2	26.0	0.49	5.2	6.5	11.7	15	N/A	N/A	N/A	N/A
	MHC / MHD											5.7	7.0	12.2	15
	MHR	265-60-1	238/304	7.4	4.7	21.0	0.33	4.7	5.9	10.7	15	N/A	N/A	N/A	N/A
	MHC / MHD											5.1	6.3	11.0	15
18	MH8 / MHR	208/230-60-1	187/253	14.3	9.2	35.0	0.49	9.2	11.5	20.6	20	N/A	N/A	N/A	N/A
	MHC / MHD											9.7	11.9	21.1	20
	MH8 / MHR	265-60-1	238/304	10.2	6.5	40.0	0.33	6.5	8.2	14.7	15	N/A	N/A	N/A	N/A
	MHC / MHD											6.9	8.5	15.0	15
24	MH8 / MHR	208/230-60-1	187/253	17.8	11.4	64.4	0.49	11.4	14.3	25.7	25	N/A	N/A	N/A	N/A
	MHC / MHD											11.9	14.8	26.2	25
	MH8 / MHR	265-60-1	238/304	16.0	10.3	60.5	0.33	10.3	12.8	23.1	20	N/A	N/A	N/A	N/A
	MHC / MHD											10.6	13.2	23.4	20
30	MH8 / MHR	208/230-60-1	187/253	19.8	12.7	75.6	0.49	12.7	15.9	28.6	25	N/A	N/A	N/A	N/A
	MHC / MHD											13.2	16.4	29.0	25
	MH8 / MHR	265-60-1	238/304	18.0	11.5	84.0	0.33	11.5	14.4	26.0	25	N/A	N/A	N/A	N/A
	MHC / MHD											11.9	14.8	26.3	25
36	MH8 / MHR	208/230-60-1	187/253	26.0	16.7	93.5	0.49	16.7	20.8	37.5	35	N/A	N/A	N/A	N/A
	MHC / MHD											17.2	21.3	38.0	35
	MH8 / MHR	265-60-1	238/304	21.0	13.5	90.8	0.33	13.5	16.8	30.3	30	N/A	N/A	N/A	N/A
	MHC / MHD											13.8	17.2	30.6	30

Notes:

- Verify electrical service is adequate for new chassis.

Wiring Diagram 96B0036N18

P Controls Standard/Fail Closed MWV

Models:
MH
09-36

TITLE: Size 09 - 36 "G", "E" & "V" Voltage, CXM or DXM, w/ "P" Controls	PCN NO: 14-0014	DATE: 01/21/14		DRAWING NO: 96B0036N18	REV: A
--	--------------------	-------------------	--	---------------------------	-----------

LEGEND: Factory Line Voltage Wiring Factory Low Voltage Wiring Optional Wiring Option Box High Pressure Switch Loss of Charge Switch Sensor, Water Coil Freeze Protection Field Low Voltage	RV Solenoid Coil RELAY/ACTUATOR COIL CAPACITOR OPTIONAL ITEMS BUTT CONNECT Splice Cap Wire Nut	Legend: CRC Compressor Run Capacitor COMPR Compressor ES Water Valve End Switch HP High Pressure Switch HPWS High Pressure Water Switch FP1 Sensor, Low Temp Protection Water Coil FP2 Sensor, Low Temp Protection Air Coil LOC Loss of Charge RAS Remote Air Sensor RVS Reversing Valve Solenoid SAC Start Assist Capacitor TBLK Terminal Block MWV Motorized Water Valve	NOTES: 1. Ext. Compr. Overload on Sizes 09, 10, 12 & 15 Only. 2. Used with TRM24/30/36 only. 3. WHEN THERE IS NO MWV END SWITCH, YELLOW JUMPER MUST BE ATTACHED AT PINS 3 & 4. 4. Optional wiring for Remote Air Sensor. Connects to 9-Pin Quick Connect In Cabinet, For Surface mounted TSTAT. 5. SPLICE CAP THE END SWITCH WIRES ON NORMALLY OPEN MOTORIZED WATER VALVE. 6. FOR USE WITH TACO PUMP. RED/YEL AND WHT WIRES ARE INSIDE PUMP WIRING BOX. 7. START ASSIST CAPACITOR FOR SIZES 9 -18 ONLY 8. Field connect blue wire, shipped loose with chassis. Part No. 11B0023N01.
--	--	--	--

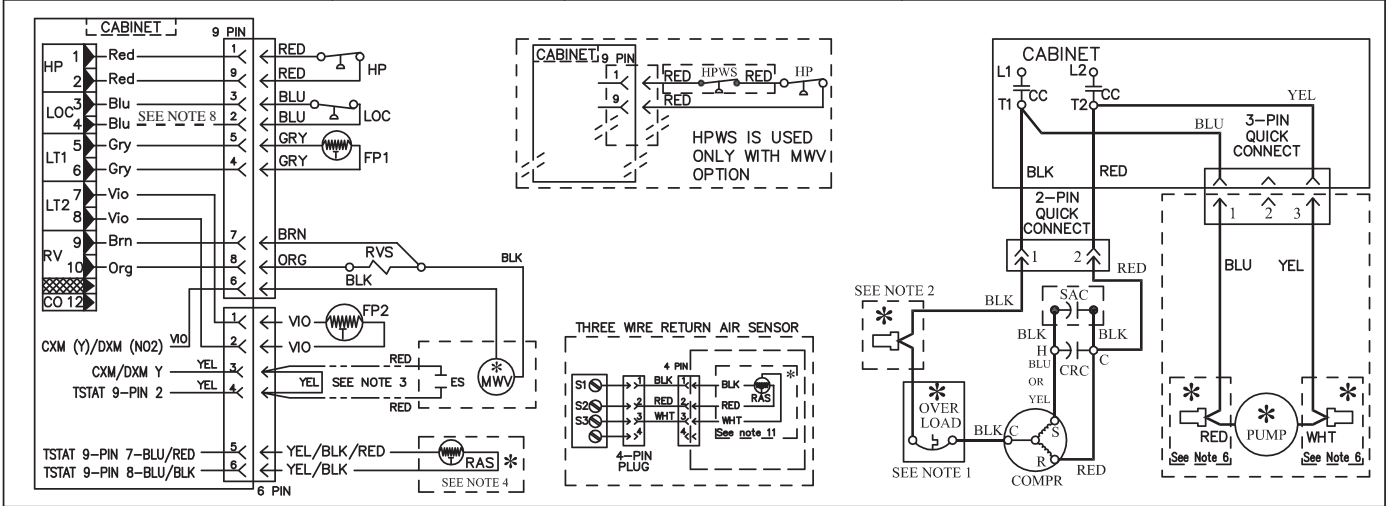

Old Cabinet	New Chassis
-------------	-------------

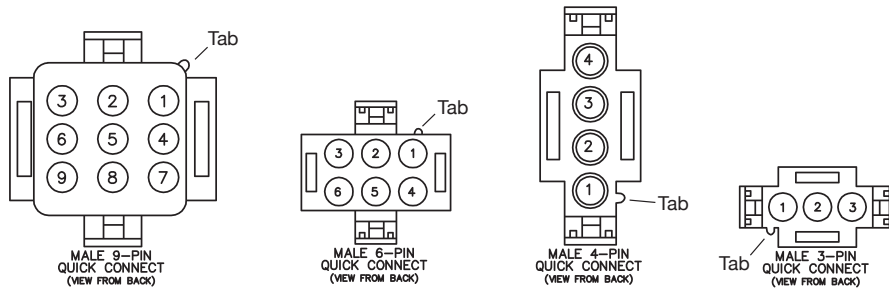

Models:
MH
09-36

MH8 Wiring Diagram 96B0036N19 P Controls Fail-Open MWV

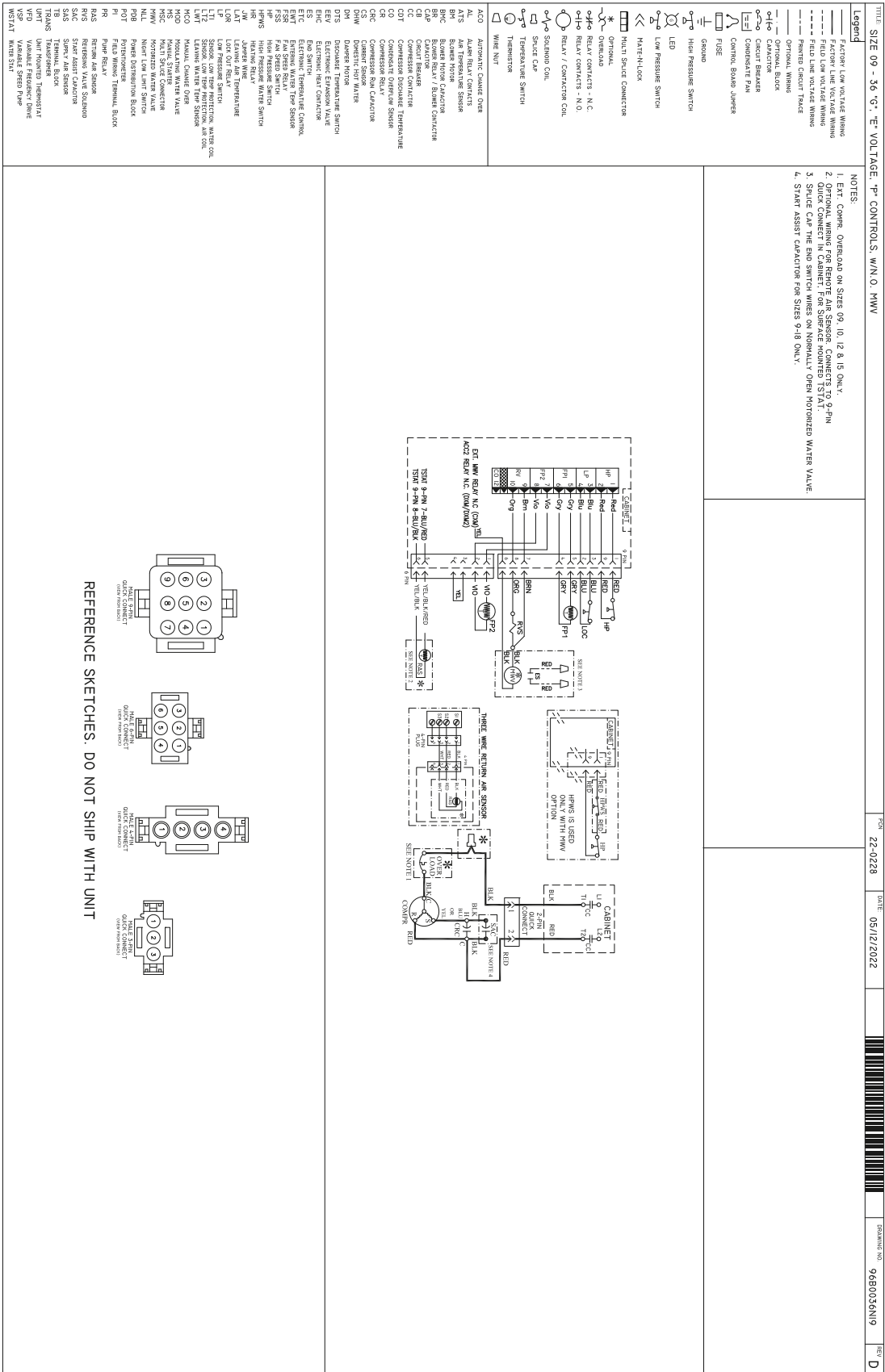

MH8 Wiring Diagram 96B0036N07 S Controls

Models:
MH
09-36

TITLE: 81709 - 36 "G" & "E" Voltage, "LINE VOLTAGE" "S" Controls		PCH NO: 16-0130	DATE: 03/18/16		DRAWING NO: 96B0036N07	REV: K	
LEGEND: _____ Factory Line Voltage Wiring _____ Factory Low Voltage Wiring - - - - - Optional Wiring [] Option Box High Pressure Switch Loss of Charge Switch FREEZE STAT		RV Solenoid Coil RELAY/ACTUATOR COIL CAPACITOR * OPTIONAL ITEMS MULTI SPLICE CONNECTOR		CRC Compressor Run Capacitor COMPR Compressor FS FREEZE STAT HP High Pressure Switch HPWS High Pressure Water Switch LTS LOW TEMP SWITCH LOC Loss of Charge LOR LOCK OUT RELAY RVS Reversing Valve Solenoid SAC Start Assist Capacitor TBLK Terminal Block		NOTES: 1. Ext. Compr. Overload on Sizes 09, 12, 15 & 18 Only. 2. Used with 81724/30/36 COMPR PLUG only. 3. START ASSIST CAPACITOR FOR SIZES 9-18 ONLY	

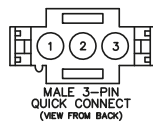
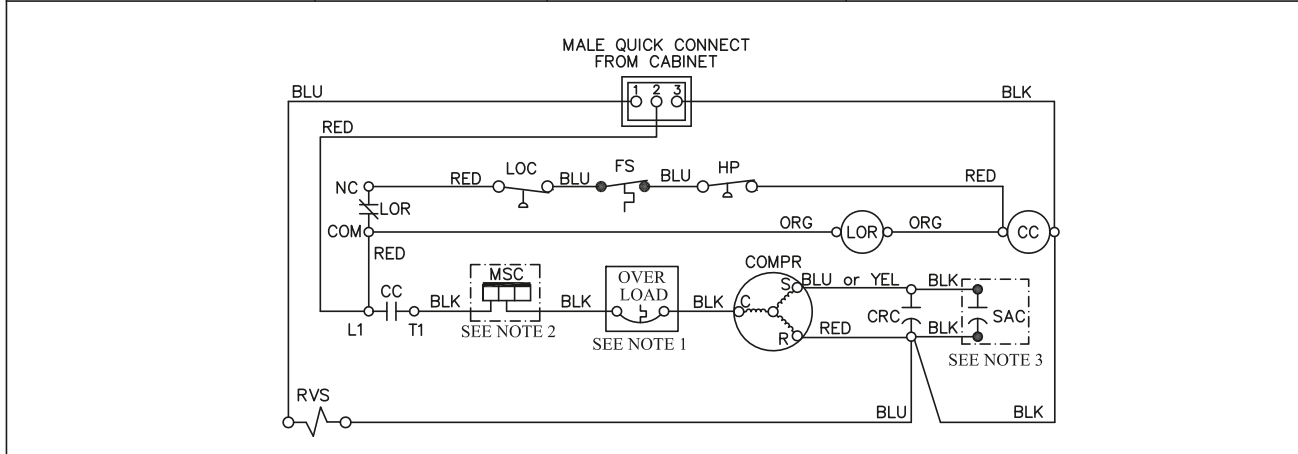





REFERENCE SKETCHES. DO NOT SHIP WITH UNIT

REV	DESCRIPTION	BY	PCH	DATE	APPR	TITLE: 817 CHASSIS 09-36 LINE VOLTAGE 817 (S) CONTROLS DRAWING NO: 96B0036N07
K	ADDED NOTE FOR SAC USED ON 81709-18	NW	16-0130	03/18/16	TN	
J	REMOVED MOTORIZED WATER VALVE OPTION	DR	14-0219	04/23/14	JIM T.	
H	REMOVED HTPS & ADDED OPTION FOR MWV w/HPWS	DR	14-0013	01/20/14	JIM T.	
G	ADDED START ASSIST CAPACITOR	DR	11-0545	11/01/11	JIM T.	
F	UPDATED LEGEND, LOR & MWV. REMOVED MWV CHECK BOX	DR	11-0121	03/18/11	JIM T.	
E	INITIAL RELEASE	DR	10-0380	08/10/10	JIM T.	

Models:
MH
09-36

MH8 Wiring Diagram 96B0036N17

M Controls

TITLE: Size 09 – 36 "G" & "E" Voltage, CMC or ELEC MECH "M" Controls		PCN NO: 21-0095	DATE: 03/02/21		DRAWING NO: 96B0036N17	REV: C	
LEGEND: ——— Factory Line Voltage Wiring ——— Factory Low Voltage Wiring - - - - - Optional Wiring - - - - - Option Box ○ High Pressure Switch ○ Loss of Charge Switch  Sensor, Water Coil Freeze Protection  RV Solenoid Coil		○ RELAY/ACTUATOR COIL ○ CAPACITOR * OPTIONAL ITEMS ● BUTT CONNECT  MULTI SPLICE CONNECTOR  Wire Nut		NOTES: 1. Ext. Compr. Overload on Sizes 09, 12, 15 & 18 Only. 2. Used with TRM24/30/36 COMPR PLUG only.			
CRC Compressor Run Capacitor COMPR Compressor HP High Pressure Switch HPWS High Pressure Water Switch LTS LOW TEMP SWITCH LOC Loss of Charge RVS Reversing Valve Solenoid SAC Start Assist Capacitor TBLK Terminal Block MWV Motorized Water Valve							

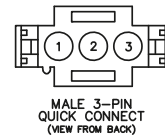
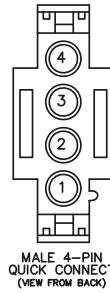
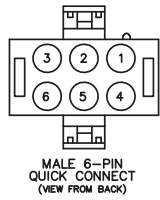
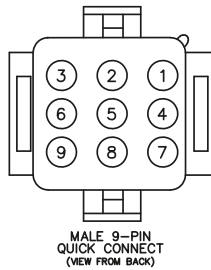
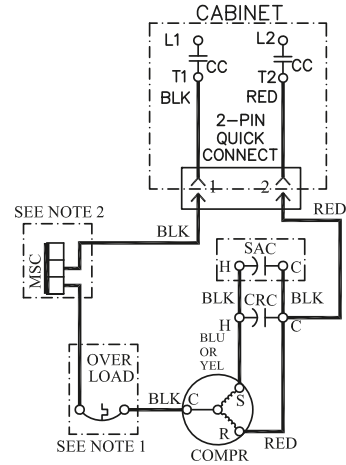
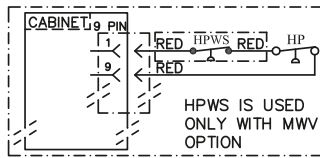
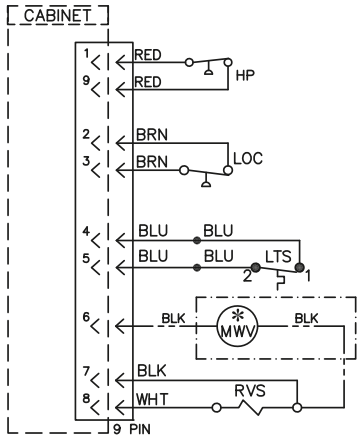

REFERENCE SKETCHES. DO NOT SHIP WITH UNIT

MHR Wiring Diagram 96B0036N19

Standard 24V TRM Controls Fail-Open MWV

Models:
MH
09-36

<p>Legend</p> <ul style="list-style-type: none"> Factory Low Voltage Wiring Field Low Voltage Wiring Printed Circuit Trace Optional Block Circuit Breaker Control Board Jumper Ground High Pressure Switch LED Low Pressure Switch Multi-Slice Connector Optional Overload Relay Contacts - N.C. Relay Contacts - N.O. Relay / Contactor Coil Solenoid Coil Slide Cap Temperature Switch Wine Nut 	<p>Notes:</p> <ol style="list-style-type: none"> EXT. COMP. OVERLOAD ON SIZES 09, 10, 12 & 15 ONLY. OPTIONAL WIRING FOR REMOTE AIR SENSOR. CONNECTS TO 9-FIN QUICK CONNECT IN CABINET. FOR SURFACE MOUNTED TSTAT. SLIDE CAP THE END SWITCH WIRES ON NORMALLY OPEN NOTORIZED WATER VALVE. START ASSY CAPACITOR FOR SIZES 9-18 ONLY. 	<p>Legend</p> <ul style="list-style-type: none"> ACO AUTOMATIC CHARGE OVER ALM ALARM RELAY CONTACT BYS BLOWER MOTOR SENSOR BVC BLOWER MOTOR CAPACITOR CBP COMPRESSOR RELAY / CONTACTOR CB CONTACT BREAKER COOT COMPRESSOR OVERHEAT SWITCH CO COMPRESSOR RELAY CR COMPRESSOR RELAY CAPACITOR CS CONTACT SWITCH DHW DOMESTIC HOT WATER DTS DISCHARGE TEMPERATURE SWITCH EEV ELECTRIC EVAPORATION VALVE ESC ELECTRIC SERVICE CONTACT ETC ELECTRONIC TEMPERATURE CONTROL FAN FAN SPEED RELAY FSS FAN SPEED SWITCH HPS HIGH PRESSURE SWITCH HRS HIGH PRESSURE WATER SWITCH HR HEATING RELAY HRM HEATING RELAY MOTOR LAV LEAVING AIR TEMPERATURE LCP LOW CHARGE PRESSURE SWITCH LTI SENSOR LOW TEMP PROTECTION, WATER COIL LWT LEAVING WATER TEMP SENSOR HCO MANUAL CHARGE OVERHEAT SWITCH HSS MANUAL STARTER MSC MULTI-SLICE CONNECTOR NLL NIGHT LOW LIMIT SWITCH PDB POWER DISTRIBUTION BLOCK POT POTENTIOMETER PR RETURN AIR SENSOR RAS RETURN AIR SENSOR RVS RETURN AIR VALVE SOLENOID SAS SENSING AIR SENSOR T8 TERMINAL BLOCK TRM TRIMMABLE RESISTOR UPT UNIT MOUNTED THERMOSTAT VFD VARIABLE FREQUENCY DRIVE VSP VARIABLE SPEED PUMP WNT WINE NUT 	<p>FIG. 22-0228 DATE: 05/12/2022</p>	<p>REFERENCE SKETCHES. DO NOT SHIP WITH UNIT</p>
--	---	--	---	---

Models:
MH
09-36

MHM, MHS, MHC, MHC Wiring Diagram 96B0434N01 TSM/TSL CXM2 w/ PSC and Fail-Closed MWV

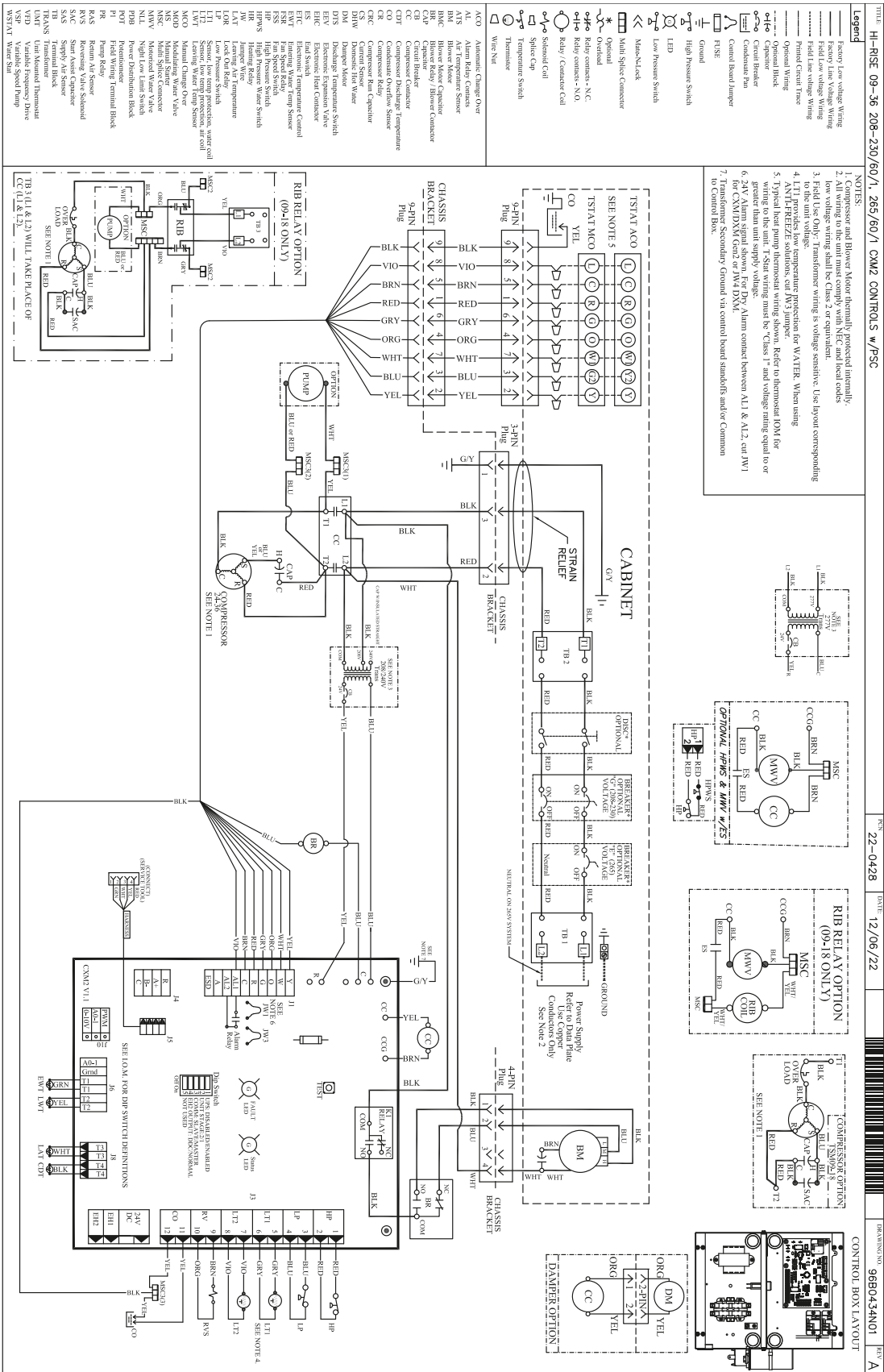

DATE: 12/06/22
 REV: 22-0428
 DRAWING NO: 96B0434N01
 REV: A

Models:
MH
09-36

Preventative Maintenance

WATER COIL MAINTENANCE (WATER LOOP APPLICATIONS)

Generally water coil maintenance is not needed for closed loop systems. However, if the piping is known to have high dirt or debris content, it is best to establish a periodic maintenance schedule with the owner so the water coil can be checked regularly. Dirty installations are typically the result of deterioration of iron or galvanized piping or components in the system. Open cooling towers requiring heavy chemical treatment and mineral buildup through water use can also contribute to higher maintenance. Should periodic coil cleaning be necessary, use standard coil cleaning procedures, which are compatible with both the heat exchanger material and copper water lines. Generally, the more water flowing through the unit, the less chance for scaling. However, flow rates over 3 GPM per ton (3.9 l/m per kW) can produce water (or debris) velocities that can erode the heat exchanger wall and ultimately produce leaks.

FILTERS

Filters must be clean to obtain maximum performance. Filters should be inspected every month under normal operating conditions and be replaced when necessary. Units should never be operated without a filter.

CONDENSATE DRAIN

In areas where airborne bacteria may produce a “slimy” substance in the drain pan, it may be necessary to treat the drain pan chemically with an algaecide approximately every three months to minimize the problem. The condensate pan may also need to be cleaned periodically to ensure indoor air quality. The condensate drain can pick up lint and dirt, especially with dirty filters. Inspect the drain twice a year to avoid the possibility of plugging and eventual overflow.

COMPRESSOR

Conduct annual amperage checks to ensure that amp draw is no more than 10% greater than indicated on the serial plate data.

AIR COIL

The air coil must be cleaned to obtain maximum performance. Check once a year under normal operating conditions and, if dirty, brush or vacuum clean. Care must be taken not to damage the aluminum fins while cleaning. CAUTION: Fin edges are sharp.

CABINET

Check inside cabinet once a year. Gently brush or vacuum clean if needed. Do not tear insulation, repair with foil tape.

REFRIGERANT SYSTEM

To maintain sealed circuit integrity, do not install service gauges unless unit operation appears abnormal. Reference the operating charts for pressures and temperatures. Verify that air and water-flow rates are at proper levels before servicing the refrigerant circuit.

All product families have transitioned to CoreMax® high flow service valves. In place of Schrader ports.

The CoreMax® system:

- Permits up to six times higher flow rate to substantially reduce refrigerant recovery and evacuation time
- Maintains compatibility with ¼-inch flare and standard-refrigeration hose connections
- Has lower leak rates than the traditional refrigerant valve/access fittings
- Requires a special tool (FasTest - SCFT20A) to replace the valve core without reclaiming, evacuating and recharging the system. The tool can be purchased directly from FasTest or check with your local supply house.

For additional information, please contact our Customer Experience team.

REPAIRS TO SEALED COMPONENTS

Sealed electrical components shall be replaced.

Startup Log Sheet

Installer: Complete *Unit and System Checkout* and follow *Unit Startup Procedures* in the IOM. Use this form to record unit information, temperatures, and pressures during startup. Keep this form for reference.

Job Name: _____

Street Address: _____

Chassis Model Number: _____

Serial Number: _____

Cabinet Model Number: _____

Serial Number: _____

Unit Location in Building: _____

Date: _____

Sales Order Number: _____

In order to minimize troubleshooting and costly system failures, complete the following checks and data entries before the system is put into full operation.

Fan Motor	Description	Value
PSC	Speed Tap	
CT EC	Speed Tap	
CV EC	CFM Setting	

Temperatures (check one): °F °C Antifreeze: _____ %

Pressures (check one): PSIG kPa Type: _____

	Cooling Mode	Heating Mode
Temperatures		
Entering Fluid Temperature		
Leaving Fluid Temperature		
Fluid Temperature Differential		
Return-Air Temperature	DB	DB
Supply-Air Temperature	DB	DB
Air Temperature Differential		
LT1		
LT2		
Discharge Line		
Leaving Air		
Voltages		
Supply at Unit		
Transformer Low Side		
Amps		
Compressor		

NOTES:

1. Allow unit to run 15 minutes in each mode before taking data.
2. Never connect refrigerant gauges during startup procedures.
3. Conduct water-side analysis using P/T ports to determine water flow and temperature difference.
4. If water-side analysis shows poor performance, refrigerant troubleshooting may be required.
5. Connect refrigerant gauges as a last resort.

Models:
MH
09-36

Functional Troubleshooting

Fault	Htg	Clg	Possible Cause	Solution
Main power problems	X	X	Green Status LED Off	Check line voltage circuit breaker and disconnect.
				Check for line voltage between L1 and L2 on the contactor.
				Check for 24VAC between R and C on CXM2/DXM2.5.
				Check primary/secondary voltage on transformer.
HP Fault Code 2 High Pressure		X	Reduced or no water flow in cooling	Check pump operation or valve operation/setting. Check water flow adjust to proper flow rate.
		X	Water Temperature out of range in cooling	Bring water temp within design parameters.
	X		Reduced or no airflow in heating	Check for dirty air filter and clean or replace.
				Check fan motor operation and airflow restrictions.
				Dirty Air Coil - construction dust etc.
				Too high of external static? Check static vs blower table.
	X		Air temperature out of range in heating	Bring return air temp within design parameters.
X	X	Overcharged with refrigerant	Check superheat/subcooling vs typical operating condition table.	
X	X	Bad HP Switch	Check switch continuity and operation. Replace.	
LP/LOC Fault Code 3	X	X	Insufficient charge	Check for refrigerant leaks.
Low Pressure / Loss of Charge	X		Compressor pump down at startup	Check charge and startup water flow.
LT1 Fault Code 4 Water coil low- temperature limit	X		Reduced or no water flow in heating	Check pump operation or water valve operation/setting.
				Plugged strainer or filter? Clean or replace.
				Check water flow. Adjust to proper flow rate.
	X		Inadequate antifreeze level	Check antifreeze density with hydrometer.
	X		Improper temperature limit setting (30°F vs 10°F [-1°C vs -2°C])	Clip JW3 jumper for antifreeze (10°F [-12°C]) use.
X		Water Temperature out of range	Bring water temp within design parameters.	
LT2 Fault Code 5 Air coil low-temperature limit		X	Reduced or no airflow in cooling	Check for dirty air filter and clean or replace. Check fan motor operation and airflow restrictions. Too high of external static? Check static vs blower table.
		X	Air Temperature out of range	Too much cold vent air? Bring entering air temp within design parameters.
		X	Improper temperature limit setting (30°F vs 10°F [-1°C vs -12°C])	Normal airside applications will require 30°F [-1°C] only.
	X	X	Bad thermistor	Check temp and impedance correlation per chart.
Condensate Fault Code 6	X	X	Blocked drain	Check for blockage and clean drain.
	X	X	Improper trap	Check trap dimensions and location ahead of vent.
		X	Poor drainage	Check for piping slope away from unit. Check slope of unit toward outlet. Poor venting? Check vent location.
		X	Moisture on sensor	Check for moisture shorting to air coil.
	X	X	Plugged air filter	Replace air filter.
	X	X	Restricted Return Airflow	Find and eliminate restriction. Increase return duct and/or grille size.

Table continued on next page.

Functional Troubleshooting

Table continued from previous page.

Fault	Htg	Cig	Possible Cause	Solution	
Over/Under Voltage Code 7 (Auto resetting)	X	X	Under Voltage	Check power supply and 24VAC voltage before and during operation.	
				Check power supply wire size.	
	X	X	Over Voltage	Check compressor starting. Need hard start kit?	
				Check 24VAC and unit transformer. Tap for correct power supply voltage.	
Unit Performance Sentinel Code 8	X		Heating mode LT2>125°F [52°C]	Check for poor airflow or overcharged unit.	
		X	Cooling Mode LT1>125°F [52°C] OR LT2< 40°F [4°C]	Check for poor water flow or airflow.	
Swapped Thermistor Code 9	X	X	LT1 and LT2 swapped	Reverse position of thermistors	
Low Water Flow Code 13	X	X	Reduced or no water flow	Check pump or valve operation setting.	
				Check water flow and adjust to proper flow rate.	
				Clogged Y strainer, replace mesh.	
	X		Inadequate antifreeze level	Check antifreeze density with hydrometer.	
	X	X	Bad flow switch	Confirm applied flow to looks vs minimum flow switch setpoint on label.	
Leaving Water Temperature Low Code 14	X		Reduced or no water flow in heating	Check pump or valve operation setting.	
				Check water flow and adjust to proper flow rate.	
	X		Inadequate antifreeze level	Check antifreeze density with hydrometer.	
				Improper temperature limit setting (30°F vs 15°F [-1°C vs -9°C])	Clip JW3 jumper for antifreeze (15°F [-9°C]) use.
				Water temperature out of range	Bring water temperature within design parameters.
X	X	Bad thermistor	Check temperature impedance correlation per chart.		
Refrigerant and RDS Code 15	X	X	Refrigerant Leak	Check refrigerant charge. If the charge is low, identify and repair the leak.	
			Faulty RDS sensor	Check refrigerant charge. If the charge is not low, replace the RDS sensor.	
No Fault Code Shown	X	X	No compressor operation	See "Only Fan Runs".	
	X	X	Compressor overload	Check and replace, if necessary.	
	X	X	Control board	Reset power and check operation.	
Unit Short Cycles	X	X	Dirty air filter	Check and clean air filter.	
	X	X	Unit in "test mode"	Reset power or wait 30 minutes for auto exit.	
	X	X	Unit selection	Unit may be oversized for space. Check sizing for actual load of space.	
	X	X	Compressor overload	Check and replace, if necessary.	
Only Fan Runs	X	X	Thermostat position	Ensure thermostat set for heating or cooling operation.	
	X	X	Unit locked out	Check for lockout codes. Reset power.	
	X	X	Compressor Overload	Check compressor overload. Replace if necessary.	
	X	X	Thermostat wiring	Check thermostat wiring at heat pump. Jumper Y and R for compressor operation in test mode.	

Table continued on next page.

Models:
MH
09-36

Functional Troubleshooting

Table continued from previous page.

Fault	Htg	Clg	Possible Cause	Solution
Only Compressor Runs	X	X	Thermostat wiring	Check G wiring at heat pump. Jumper G and R for fan operation.
	X	X		Check thermostat wiring at heat pump. Jumper Y and R for compressor operation in test mode.
	X	X	Fan motor relay	Jumper G and R for fan operation. Check for line voltage across BR contacts.
	X	X		Check fan power enable relay operation (if present).
	X	X	Fan motor	Check for line voltage at motor. Check capacitor.
Unit Doesn't Operate in Cooling		X	Reversing valve	Set for cooling demand and check 24VAC on RV coil and at CXM2/DXM2.5.
		X		If RV is stuck, run high pressure up by reducing water flow and while operating engage and disengage RV coil voltage to push valve.
		X	Thermostat setup	Check for 'O' RV setup not 'B'.
		X	Thermostat wiring	Check O wiring at heat pump. Jumper O and R for RV coil 'click'.
		X		Put thermostat in cooling mode. Check 24VAC on O (check between C and O); check for 24VAC on W (check between W and C). There should be voltage on O, but not on W. If voltage is present on W, thermostat may be bad or wired incorrectly.

Performance Troubleshooting

Symptom	Htg	Clg	Possible Cause	Solution
Insufficient capacity/ Not cooling or heating	X	X	Dirty filter	Replace or clean.
	X		Reduced or no airflow in heating	Check for dirty air filter and clean or replace.
				Check fan motor operation and airflow restrictions.
				Too high of external static? Check static vs. blower table.
		X	Reduced or no airflow in cooling	Check for dirty air filter and clean or replace.
				Check fan motor operation and airflow restrictions.
				Too high of external static? Check static vs. blower table.
	X	X	Leaky duct work	Check supply and return air temperatures at the unit and at distant duct registers. If significantly different, duct leaks are present.
	X	X	Low refrigerant charge	Check superheat and subcooling per chart.
	X	X	Restricted metering device	Check superheat and subcooling per chart. Replace.
		X	Defective reversing valve	Perform RV touch test.
X	X	Thermostat improperly located	Check location and for air drafts behind stat.	
X	X	Unit undersized	Recheck loads & sizing. Check sensible cooling load and heat pump capacity.	
X	X	Scaling in water heat exchanger	Perform scaling check and clean if necessary.	
X	X	Inlet water too hot or cold	Check load, loop sizing, loop backfill, ground moisture.	
High Head Pressure	X		Reduced or no airflow in heating	Check for dirty air filter and clean or replace.
				Check fan motor operation and airflow restrictions.
				Too high of external static? Check static vs. blower table.
		X	Reduced or no water flow in cooling	Check pump operation or valve operation/setting. Check water flow. Adjust to proper flow rate.
		X	Inlet water too hot	Check load, loop sizing, loop backfill, ground moisture.
	X		Air temperature out of range in heating	Bring return air temperature within design parameters.
		X	Scaling in water heat exchanger	Perform scaling check and clean if necessary.
	X	X	Unit overcharged	Check superheat and subcooling. Re-weigh in charge.
X	X	Non-condensables in system	Vacuum system and re-weigh in charge.	
X	X	Restricted metering device	Check superheat and subcooling per chart. Replace.	
Low Suction Pressure	X		Reduced water flow in heating	Check pump operation or water valve operation/setting.
				Plugged strainer or filter? Clean or replace.
				Check water flow. Adjust to proper flow rate.
	X		Water temperature out of range	Bring water temperature within design parameters.
		X	Reduced airflow in cooling	Check for dirty air filter and clean or replace.
				Check fan motor operation and airflow restrictions. Too high of external static? Check static vs. blower table.
	X	Air temperature out of range	Too much cold vent air? Bring entering air temperature within design parameters.	
X	X	Insufficient charge	Check for refrigerant leaks.	
Low Discharge Air Temperature in Heating	X		Too high of airflow	Check fan motor speed selection and airflow chart.
	X		Poor performance	See 'Insufficient Capacity'

Table continued on next page.

Models:
MH
09-36

Performance Troubleshooting

Table continued from previous page.

Symptom	Htg	Clg	Possible Cause	Solution
High humidity		X	Too high of airflow	Check fan motor speed selection and airflow chart.
		X	Unit oversized	Recheck loads & sizing. Check sensible cooling load and heat pump capacity.
Only Compressor Runs	X	X	Thermostat wiring	Check G wiring at heat pump. Jumper G and R for fan operation.
	X	X	Fan motor relay	Jumper G and R for fan operation. Check for line voltage across blower relay contacts. Check fan power. Enable relay operation (if present).
	X	X	Fan motor	Check for line voltage at motor. Check capacitor.
	X	X	Thermostat wiring	Check thermostat wiring at CXM2. Put in Test Mode and then jumper Y1 and W1 to R to give call for fan, compressor and electric heat.
Unit Doesn't Operate in Cooling		X	Reversing valve	Set for cooling demand and check 24VAC on RV coil. If RV is stuck, run high pressure up by reducing water flow and, while operating, engage and disengage RV coil voltage to push valve.
		X	Thermostat setup	Check for "O" RV setup, not "B".
		X	Thermostat wiring	Check O wiring at heat pump. CXM2 requires call for compressor. You should hear a "click" sound from the reversing valve.
Modulating Valve Troubleshooting	X	X	Improper output setting	Verify the AO-2 jumper is in the 0-10V position.
	X	X	No valve output signal	Check DC voltage between AO2 and GND. Should be 0 when valve is off and between 3.3V and 10V when valve is on.
	X	X	No valve operation	Check voltage to the valve. Replace valve if voltage and control signals are present at the valve and it does not operate.

Troubleshooting Form

Water-to-Air Units

Customer: _____ Loop Type: _____ Startup Date: _____

Model #: _____ Serial #: _____ Antifreeze Type & %: _____

Complaint: _____

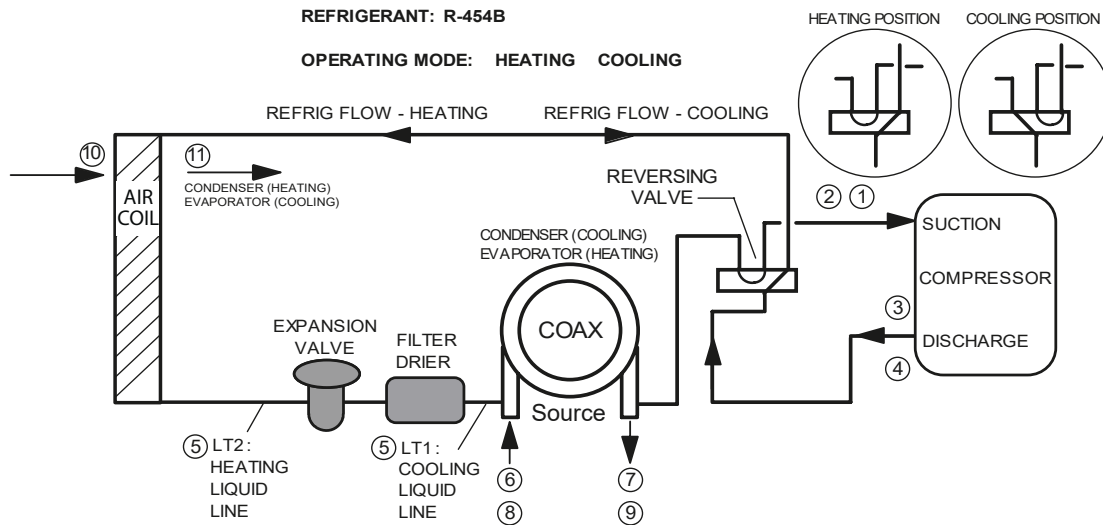

Description	Heating	Cooling	Notes
Voltage			
Compressor Amps			
1 Suction Temp			
2 Suction Press			
2a Saturation Temp			
2b Superheat			
3 Discharge Temp			
4 Discharge Press			
4a Saturation Temp			
4b Subcooling			
5 Liquid Line Temp			
6 Source Water In Tmp			
7 Source Water Out Tmp			Temp Diff. =
8 Source Water In Pres			
9 Source Water Out Pres			
9a Press Drop			
9b Flow Rate			
10 Return Air Temp			
11 Supply Air Temp			

Heat of Extraction (Absorption) or Heat of Rejection:

Fluid Factor: (for Btuh)
500 (Water); 485 (Antifreeze)

Fluid Factor: (for kW)
4.18 (Water); 4.05 (Antifreeze)

HE or HR =

_____ Flow Rate x _____ Temp. Diff x _____ Fluid Factor

Superheat = Suction temperature - suction saturation temp. = _____ (deg F)

Subcooling = Discharge saturation temp. - liquid line temp. = _____ (deg F)

Models:
MH
09-36

Revision History

Date	Section	Description
12/20/24	All	Created



1900 Wellworth Ave | Jackson, MI 49203
Phone: 517.787.2100
www.marsdelivers.com



Due to ongoing product improvements, specifications and dimensions are subject to change and correction without notice or incurring obligations. Determining the application and suitability for use of any product is the responsibility of the installer. Additionally, the installer is responsible for verifying dimensional data on the actual product prior to beginning any installation preparations.

Incentive and rebate programs have precise requirements as to product performance and certification. All products meet applicable regulations in effect on date of manufacture; however, certifications are not necessarily granted for the life of a product. Therefore, it is the responsibility of the applicant to determine whether a specific model qualifies for these incentive/rebate programs.

Engineered and assembled in the USA.

© MARS, Inc. All Rights Reserved 2024